

Installation instructions

Permo® - Breathable Underlay

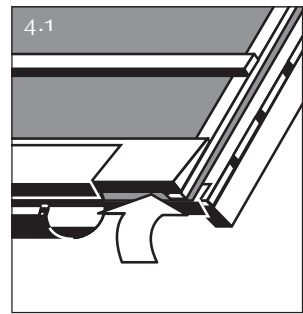

Details

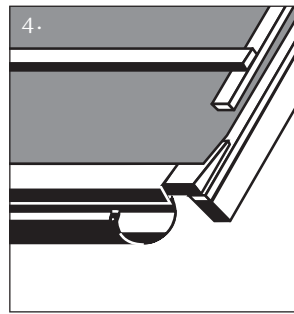
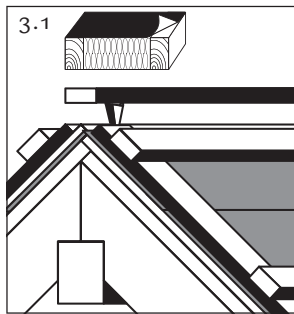
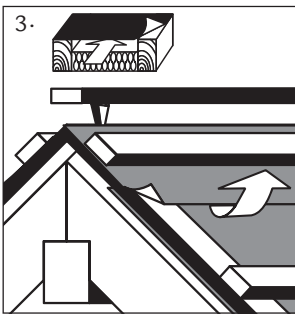
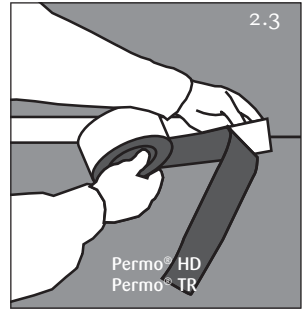
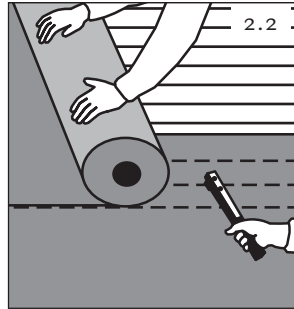
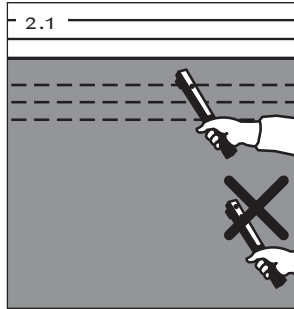
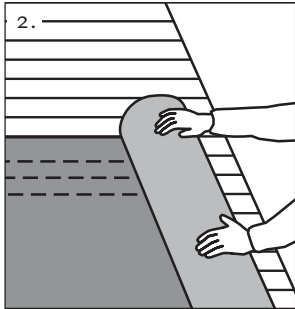
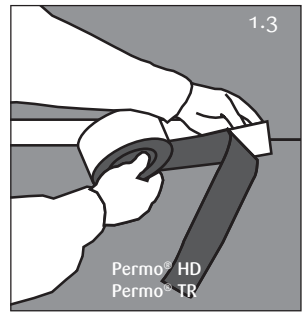
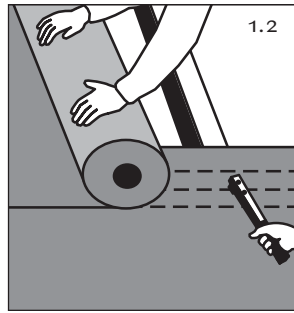
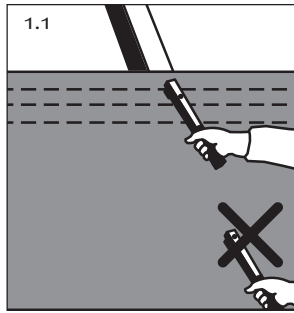
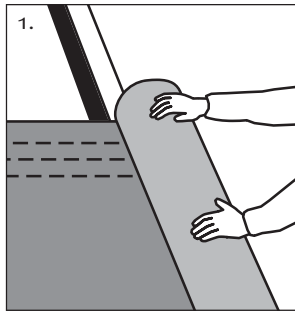
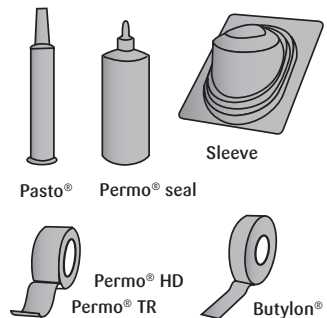
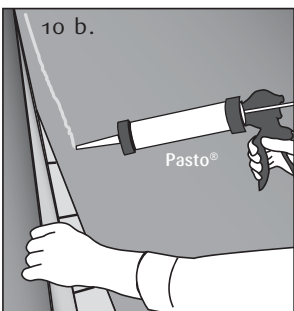
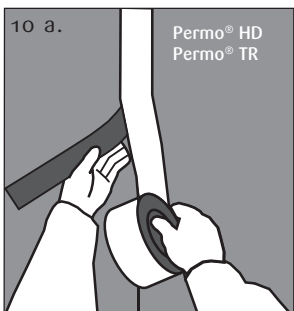
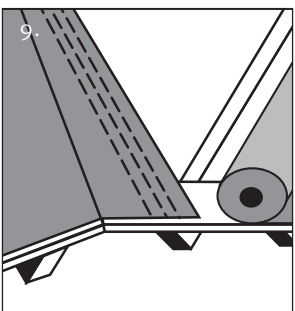
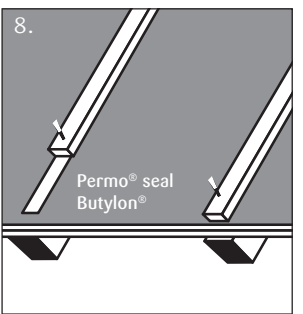
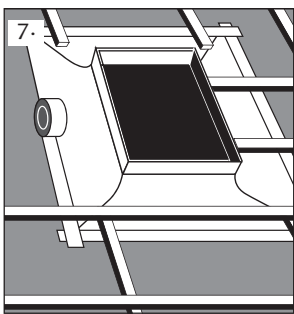
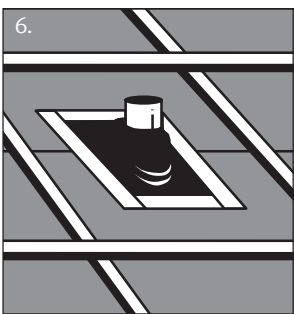
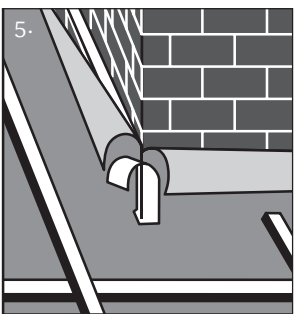

Permo® easy H

Entspricht dem ZVDH- Produktdatenblatt Unterdeckbahnen Klasse UDB-B gemäß Tabelle 1
Entspricht dem ZVDH- Produktdatenblatt Unterspannbahnen Klasse USB-A gemäß Tabelle 1

Permo® light/forte

Entspricht dem ZVDH- Produktdatenblatt Unterdeckbahnen Klasse UDB-A gemäß Tabelle 1
Entspricht dem ZVDH- Produktdatenblatt Unterspannbahnen Klasse USB-A gemäß Tabelle 1



www.kloeber.biz

Bitte beachten Sie die aktuelle Fassung der ZVDH-Richtlinie.

KLOEBER

Installation instructions

Permo® - Breathable Underlay (SK² Version)

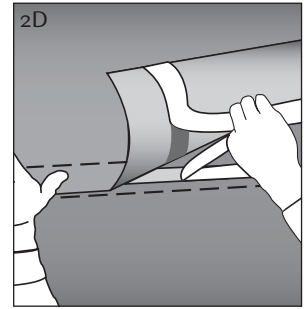
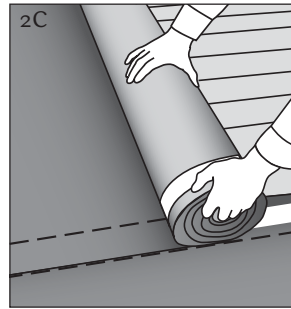
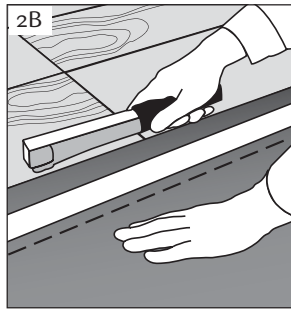
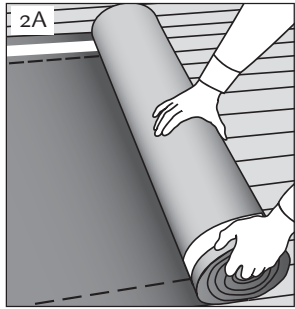
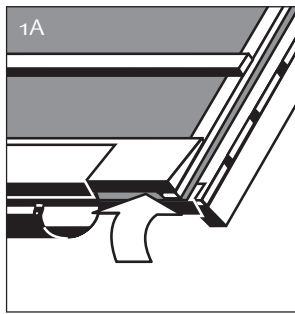

Details

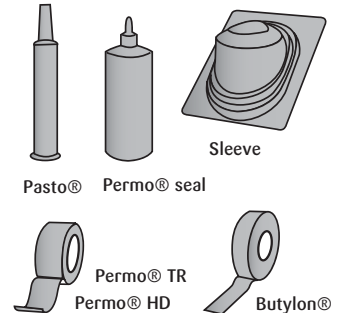
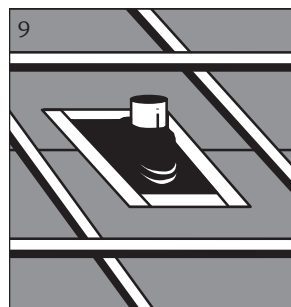
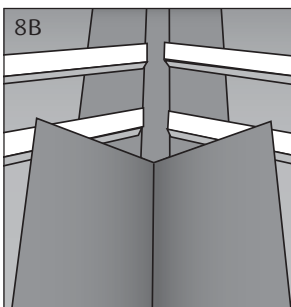
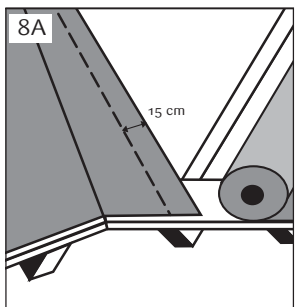
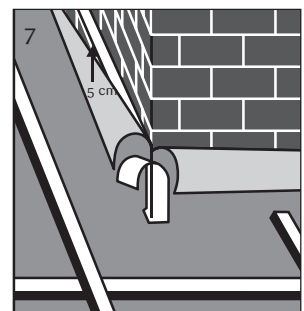
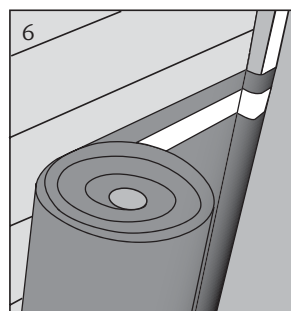
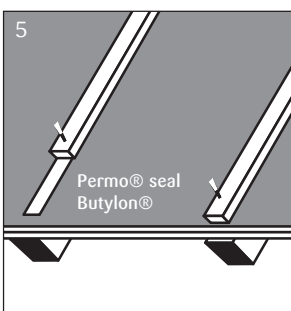
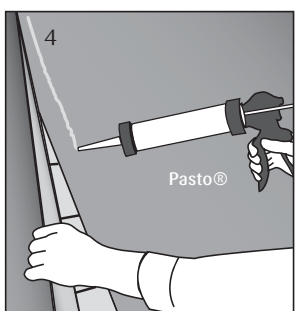
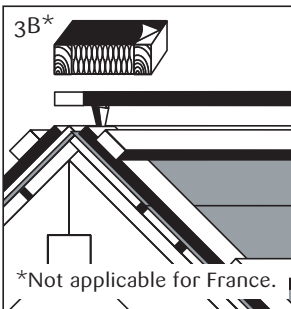
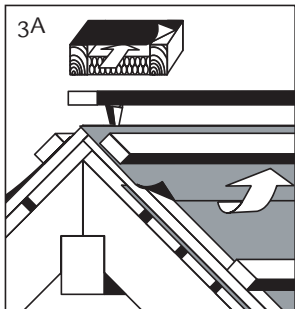

Permo® light/forte

Entspricht dem ZVDH- Produktdatenblatt Unterdeckbahnen Klasse UDB-A gemäß Tabelle 1
Entspricht dem ZVDH- Produktdatenblatt Unterspannbahnen Klasse USB-A gemäß Tabelle 1

Permo® easy H

Entspricht dem ZVDH- Produktdatenblatt Unterdeckbahnen Klasse UDB-B gemäß Tabelle 1
Entspricht dem ZVDH- Produktdatenblatt Unterspannbahnen Klasse USB-A gemäß Tabelle 1



www.kloeber.biz

Bitte beachten Sie die aktuelle Fassung der ZVDH Richtlinie.

KLOEBER