

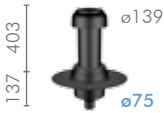













WOHNRAUM BE- UND ENTLÜFTUNG PRODUKTÜBERSICHT SETS, WÄRMEGEDÄMMT

		DN 75	DN 110	DN 125	DN 160
belüftetes Dach	 PPO-Flansch (Flanschdurchmesser 490 mm)	 ø139 / ø75 137 / 403 KF 7000-70	 ø139 / ø110 137 / 403 KF 7000-100	 ø187 / ø125 137 / 417 KF 7000-125	 ø187 / ø160 137 / 417 KF 7000-150
	 Bitumen-Manschette (Manschettenmaß 500 x 500 mm)	 ø139 / ø75 137 / 403 KF 7001-70	 ø139 / ø110 137 / 403 KF 7001-100	 ø187 / ø125 137 / 417 KF 7001-125	 ø187 / ø160 137 / 417 KF 7001-150
	 Kunststoff-Manschette nach Wahl (Manschettenmaß 500 x 500 mm)	 ø139 / ø75 137 / 403 KF 7002-70-xx	 ø139 / ø110 137 / 403 KF 7002-100-xx	 ø187 / ø125 137 / 417 KF 7002-125-xx	 ø187 / ø160 137 / 417 KF 7002-150-xx



BE- UND ENTLÜFTER ALS DACHDURCHFÜHRUNG

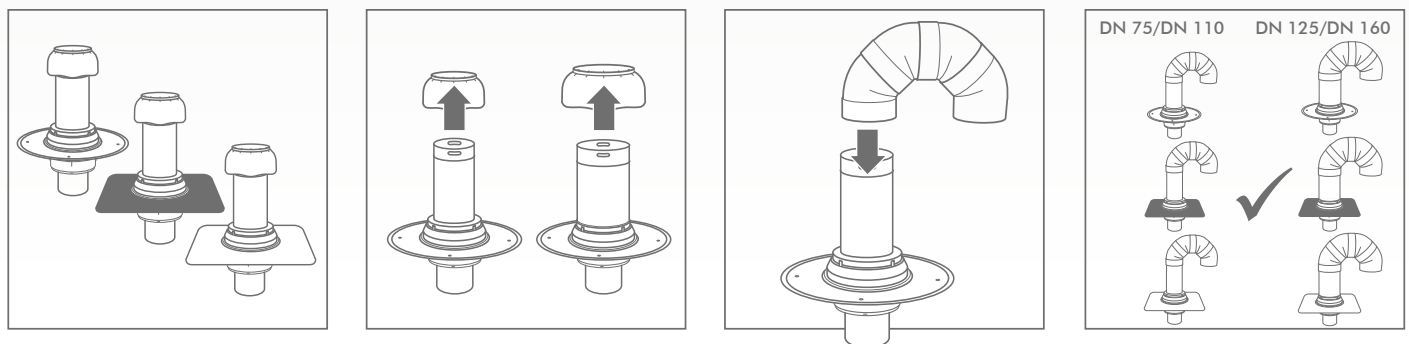

WOHNRAUM BE- UND ENTLÜFTUNG PRODUKTÜBERSICHT SETS, WÄRMEGEDÄMMT

		DN 75	DN 110	DN 125	DN 160
 <p>unbelüftetes Dach</p>	 <p>PPO-Flansch (Flanschdurchmesser 490 mm)</p>	 <p>274 403 ø139 ø160 KF 7020-710</p>		 <p>274 417 ø187 ø160 KF 7020-1215</p>	
	 <p>Bitumen-Manschette (Manschettenmaß 500 x 500 mm)</p>	 <p>274 403 ø139 ø160 KF 7021-710</p>		 <p>274 417 ø187 ø160 KF 7021-1215</p>	
	 <p>Kunststoff-Manschette nach Wahl (Manschettenmaß 500 x 500 mm)</p>	 <p>274 403 ø139 ø160 KF 7022-710-xx</p>		 <p>274 417 ø187 ø160 KF 7022-1215-xx</p>	

		DN 75	DN 110	DN 125	DN 160
 <p>unbelüftetes Dach</p>	 <p>PPO-Flansch (Unterteil ohne Dämmhülse) (Flanschdurchmesser 490 mm)</p>	 <p>230 ø75 KF 7400-70</p>	 <p>230 ø110 KF 7400-100</p>	 <p>230 ø125 KF 7400-125</p>	 <p>230 ø160 KF 7400-150</p>
	 <p>Bitumen-Manschette (Manschettenmaß 500 x 500 mm)</p>	 <p>230 ø75 KF 7401-70</p>	 <p>230 ø110 KF 7401-100</p>	 <p>230 ø125 KF 7401-125</p>	 <p>230 ø160 KF 7401-150</p>

		DN 75	DN 110	DN 125	DN 160
<p>Dämmpaketverlängerung, bestehend aus</p>					
<p>Flavent pro Adapterrohr Beliebig verlängerbar. Zusätzliche Lippendichtung (KF 7549) ist separat zu bestellen. Erforderlich ab Dämmstoffdicken: > 250 mm bei Dachabläufen > 160 mm bei Lüftern Verlängert um 110 mm</p>				 <p>175 ø160 KF 7743-150</p>	
<p>Flavent pro Lippendichtung Für Flavent pro Adapterrohr (KF 7743-150).</p>				 <p>KF 7549</p>	